

General Medicine and ENT Instruments

THE BEST IN QUALITY AND PERFORMANCE

High tech materials, the latest production processes and innovative design are three factors which contribute to the excellent quality of HEINE Oscopes. They produce excellent image quality with uniquely bright and reflex-free illumination of the tympanum and auditory canal.

HEINE Oscopes are available for various applications with distal fiber optic (F.O.) or direct bulb illumination with bright HEINE XHL Xenon halogen bulbs.





HEINE Otoscopes



BETA200 F.O. K180 F.O. mini3000 F.O. mini3000 LED F.O. BETA100 K100 Operating Otoscope mini3000

	Housing construction							
Metal	<input type="checkbox"/>				<input type="checkbox"/>		<input type="checkbox"/>	
Polycarbonate		<input type="checkbox"/>	<input type="checkbox"/>	<input type="checkbox"/>		<input type="checkbox"/>		<input type="checkbox"/>
	Viewing window							
Glass	<input type="checkbox"/>				<input type="checkbox"/>			
Acrylic		<input type="checkbox"/>	<input type="checkbox"/>	<input type="checkbox"/>		<input type="checkbox"/>		<input type="checkbox"/>
3x magnification	<input type="checkbox"/>	<input type="checkbox"/>	<input type="checkbox"/>	<input type="checkbox"/>	<input type="checkbox"/>	<input type="checkbox"/>	2,5x	<input type="checkbox"/>
	Illumination							
LED F.O.				<input type="checkbox"/>				
XHL F.O.	<input type="checkbox"/>	<input type="checkbox"/>	<input type="checkbox"/>					
XHL Direct					<input type="checkbox"/>	<input type="checkbox"/>	<input type="checkbox"/>	<input type="checkbox"/>
	Instrument size							
Professional	<input type="checkbox"/>	<input type="checkbox"/>			<input type="checkbox"/>	<input type="checkbox"/>	<input type="checkbox"/>	
Compact			<input type="checkbox"/>	<input type="checkbox"/>				<input type="checkbox"/>
	Available power sources							
Battery 2.5V	<input type="checkbox"/>	<input type="checkbox"/>	<input type="checkbox"/>	<input type="checkbox"/>	<input type="checkbox"/>	<input type="checkbox"/>	<input type="checkbox"/>	<input type="checkbox"/>
Rechargeable battery 2.5V			<input type="checkbox"/>	<input type="checkbox"/>				<input type="checkbox"/>
Rechargeable battery 3.5V	<input type="checkbox"/>	<input type="checkbox"/>			<input type="checkbox"/>	<input type="checkbox"/>	<input type="checkbox"/>	
	Tips							
Reusable tips	<input type="checkbox"/>	<input type="checkbox"/>	<input type="checkbox"/>	<input type="checkbox"/>				<input type="checkbox"/>
Reusable Specula					<input type="checkbox"/>	<input type="checkbox"/>	<input type="checkbox"/>	
AllSpec Disposable tips	<input type="checkbox"/>	<input type="checkbox"/>	<input type="checkbox"/>	<input type="checkbox"/>	<input type="checkbox"/>	<input type="checkbox"/>	<input type="checkbox"/>	<input type="checkbox"/>
UniSpec Disposable								
Specula					<input type="checkbox"/>	<input type="checkbox"/>	<input type="checkbox"/>	
Tip-Adaptor					<input type="checkbox"/>	<input type="checkbox"/>	<input type="checkbox"/>	
	Insufflation Bulb							
Insufflation port	<input type="checkbox"/>	<input type="checkbox"/>	<input type="checkbox"/>	<input type="checkbox"/>	<input type="checkbox"/>	<input type="checkbox"/>		
Page	009	011	012	014	017	019	021	022

* with Tip-Adaptor

** Optional insufflation port connector available



High-quality Fiber Optic (F.O.) illumination with high-intensity XHL Xenon Halogen bulb.

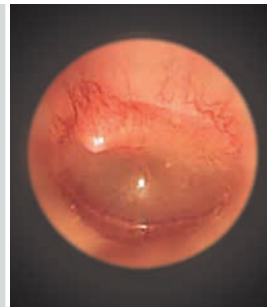
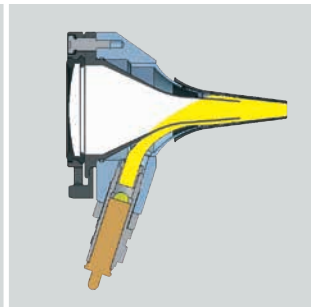

HEINE BETA® 200 Fiber Optic (F.O.) Otoscope

The ultimate in performance and quality

Solid, all-metal construction. A quality instrument for the physician's office with Fiber Optic (F.O.) illumination.



- ∴ **All-metal housing matt-chrome-plated.** Durable, long-lasting and easy to clean.
- ∴ **Instrument head matt-black inside.** Eliminates reflexes.
- ∴ **Distal Fiber Optic (F.O.) illumination with XHL Xenon Halogen Technology.** Homogeneous, reflex-free illumination of ear canal and tympanum.
- ∴ Large, scratch-resistant **glass viewing window made of multi-coated optical glass with 3x magnification.** Unobstructed edge-to-edge view, distortion-free image.
- ∴ **Swivelling viewing window built into instrument.** Useful for instrumentation, cannot be mislaid.
- ∴ **Insufflation port.** Reliable test of tympanic mobility.

- ∴ Fiber Optic (F.O.) illumination
- ∴ All-metal housing
- ∴ 3x magnification
- ∴ Silica glass viewing window

BETA 200 F.O. Otoscope	2.5V	3.5V
with 4 reusable tips, without handle	B-001.11.501	B-002.11.501
same, without tips, without handle	B-001.11.500	B-002.11.500
XHL Xenon Halogen spare bulb	X-001.88.077	X-002.88.078

HEINE BETA® 200 Fiber Optic (F.O.) ENT Diagnostic Sets

Set complete with: **BETA 200 Fiber Optic (F.O.) Otoscope**
 1 set (4 pcs.) of reusable tips (B-000.11.111)
 5 of both AllSpec disposable tips 2.5 and 4 mm Ø (B-000.11.119)
 spare bulb
 hard case



BETA 200 F.O. Otoscope Sets	2.5V	3.5V (NiMH)	3.5V
BETA battery handle	B-141.10.118		
BETA R rechargeable handle for mains socket		B-141.20.376	B-141.27.376
BETA TR rechargeable handle with plug-in transformer		B-141.20.384	B-141.27.384
BETA NT rechargeable handle and NT300 charger		B-141.20.420	
BETA L rechargeable handle and NT300 charger			B-141.29.420



: Rechargeable handle with charge status display in the bottom insert.



HEINE BETA® 200 Fiber Optic (F.O.) Diagnostic Sets



Set complete with: **BETA 200 Ophthalmoscope, BETA 200 F.O. Otoscope,**
1 set (4 pcs.) of reusable tips (B-000.11.111)
5 of both AllSpec disposable tips 2.5 and 4 mm Ø (B-000.11.119)
one spare bulb each
hard case

BETA 200 F.O. Diagnostic Sets	2.5V	3.5V (NiMH)	3.5V 
BETA battery handle	A-132.10.118		
BETA R rechargeable handle for mains socket		A-132.20.376	A-132.27.376
BETA TR rechargeable handle with plug-in transformer		A-132.20.384	A-132.27.384
BETA NT rechargeable handle and NT300 charger		A-132.20.420	
 BETA L rechargeable handle and NT300 charger			A-132.29.420

: Rechargeable handle with charge status display in the bottom insert.

HEINE K180® Fiber Optic (F.O.) Otoscope

The standard, all around Fiber Optic Otoscope



Otoscope with Fiber Optic (F.O.) illumination constructed of light, high-impact polycarbonate and **3x magnification** scratch-resistant acrylic viewing window. Otherwise technically identical to the BETA200 F.O. Otoscope.

- Fiber Optic (F.O.) illumination
- Polycarbonate construction

K180 F.O. Otoscope	2.5V	3.5V
with 4 reusable tips, without handle	B-001.11.551	B-002.11.551
same, without tips, without handle	B-001.11.550	B-002.11.550
XHL Xenon Halogen spare bulb	X-001.88.077	X-002.88.078

HEINE K180® Fiber Optic (F.O.) Diagnostic Sets

Set complete with: **K180 Fiber Optic (F.O.) Otoscope**
 1 set (4 pcs.) of reusable tips (B-000.11.111)
 soft pouch



K180 F.O. Otoscope Sets	2.5V	3.5V (NiMH)	3.5V
BETA battery handle	B-181.10.118		
BETA R rechargeable handle for mains socket		B-181.20.376	B-181.27.376
BETA TR rechargeable handle with plug-in transformer		B-181.20.384	B-181.27.384
BETA NT rechargeable handle and NT300 charger		B-181.20.420	
BETA L rechargeable handle and NT300 charger			B-181.29.420

Set complete with **K180 Ophthalmoscope, K180 Fiber Optic (F.O.) Otoscope**
 1 set (4 pcs.) of reusable tips (B-000.11.111)
 hard case



K180 Combined Diagnostic Sets	2.5V	3.5V (NiMH)	3.5V
BETA battery handle	A-279.10.118		
BETA R rechargeable handle for mains socket		A-279.20.376	A-279.27.376
BETA TR rechargeable handle with plug-in transformer		A-279.20.384	A-279.27.384
BETA NT rechargeable handle and NT300 charger		A-279.20.420	
BETA L rechargeable handle and NT300 charger			A-279.29.420

: Rechargeable handle with charge status display in the bottom insert.



HEINE mini3000® Fiber Optic (F.O.) Otoscope

Compact pocket otoscope with Fiber Optic (F.O.) illumination



Modern pocket otoscope in a unique, compact design. Handy and powerful. Can only be used with the mini3000 handle system. Available in black or blue.

- ∴ **Xenon Halogen** bulbs for bright illumination and accurate colour rendering.
- ∴ **20,000 ON/OFF** switch cycles guaranteed.
- ∴ **Distal Fiber Optic (F.O.) Illumination:** Reflex-free illumination of tympanum and ear canal.
- ∴ **Viewing window with 3x magnification and optimized casing surface for razor-sharp images and minimal reflection. Swivelling viewing window built into instrument.**
- ∴ **Pneumatic testing** of the tympanum mobility by using the insufflation port and an optional connector.
- ∴ **Attachment clip with integrated on/off switch.** Switches off automatically when returned to the pocket.
- ∴ **Replaceable batteries.** Size AA, or optional rechargeable battery with mini NT table charger.*
- ∴ **2-piece handle and head.** Easy to maintain, flexible.
- ∴ **Award-winning design.** Maximum quality with minimum dimensions.

∴ Modern pocket otoscope

∴ Fiber Optic (F.O.) illumination

∴ Port for pneumatic testing

mini3000 F.O. Otoscope	2.5V
with mini3000 battery handle, 1 set (4 pcs.) reusable tips and 5 of both 2.5 and 4 mm dia. AllSpec disposable tips, with batteries	D-001.70.120
with mini3000 battery handle and 5 of both 2.5 and 4 mm dia. AllSpec disposable tips, with batteries	D-001.70.110
with mini3000 rechargeable handle and 5 of both 2.5 and 4 mm dia. AllSpec disposable tips (please order mini NT table charger separately)	D-001.70.301
mini3000 F.O. Otoscope head without handle and without accessories	D-001.70.106
XHL Xenon Halogen spare bulb	X-001.88.105
Insufflation port connector for mini3000 F.O. Oscopes	D-000.80.101



*To upgrade to a rechargeable instrument with mini NT table charger, please see page 146.

HEINE mini3000 pocket instruments – a complete range of quality diagnostic instruments for your pocket. Available in black or blue. Please specify the colour you prefer when ordering. If not otherwise specified, we will supply black instruments.

HEINE mini3000® Fiber Optic (F.O.) Diagnostic Sets



Set complete with: **mini3000 Fiber Optic (F.O.) Otoscope**
 1 set (4 pcs.) reusable tips (B-000.11.111)
 5 each of 2.5 and 4 mm dia. AllSpec disposable tips (B-000.11.119)
 hard case

mini3000 Fiber Optic (F.O.) Diagnostic Sets	2.5V
with mini3000 battery handle with batteries	D-851.10.021



Set complete with: **mini3000 Ophthalmoscope, mini3000 F.O. Otoscope,**
 1 set (4 pcs.) reusable tips (B-000.11.111)
 5 each of 2.5 and 4 mm dia. AllSpec disposable tips (B-000.11.119)
 hard case

mini3000 Fiber Optic (F.O.) Diagnostic Sets	2.5V
with 2 mini3000 battery handles with batteries	D-873.11.021



Set complete with: **mini3000 Ophthalmoscope, mini3000 F.O. Otoscope,**
 mini NT table charger
 5 each of 2.5 and 4 mm dia. AllSpec disposable tips (B-000.11.119)

mini3000 Fiber Optic (F.O.) Diagnostic Sets	2.5V
with 2 mini3000 rechargeable handles	D-859.11.022*

*with this Art. No. only available in black.



HEINE mini3000® LED Fiber Optic (F.O.) Otoscope with LED Illumination in HEINE Quality HQ

LED HQ
LED NOW IN HEINE QUALITY.



- ⚡ Maintenance-free pocket instrument
- ⚡ Bright LED illumination
- ⚡ Up to 10 hours operation time

Modern otoscope with maintenance-free LED illumination. Twice as bright as a conventional Xenon Halogen instrument.

All of the features of the mini3000 F.O. Otoscope, with the addition of:

- ⚡ **Maintenance-free**, no need to ever exchange the LED.
- ⚡ LED Thermal management for a **consistent light output throughout the whole working life**.
- ⚡ High-performance-LED: bright and absolutely homogeneous **illumination with excellent colour rendering** – colour temperature 4000K, colour rendering index >95, and >90 rendering index of the colour red.
- ⚡ **Twice as bright as** Xenon Halogen instruments.
- ⚡ **Exclusive Battery Performance Indicator:** When the instrument is switched on, the maximum light intensity is shown, then the light intensity is regulated down to the level that corresponds to the current charge status of the battery so you know when your batteries need changing.
- ⚡ **Exclusive fade-out function** reduces illumination intensity with battery level to let you know when to replace.
- ⚡ **Operation time up to 10 hours.** The batteries need to be changed less often and the rechargeable batteries last longer.

mini 3000 LED F.O. Otoscope	2.5V
with mini3000 battery handle, 1 set (4 pcs.) reusable tips and 5 of both 2.5 and 4 mm dia. AllSpec disposable tips, with batteries	D-008.70.120
with mini3000 battery handle and 5 of both 2.5 and 4 mm dia. AllSpec disposable tips, with batteries	D-008.70.110
with mini3000 rechargeable handle and 5 of both 2.5 and 4 mm dia. AllSpec disposable tips (please order mini NT table charger separately)	D-008.70.301
mini3000 LED F.O. Otoscope head without handle and without accessories	D-008.70.106
Insufflation port connector for mini3000 F.O. Otoscopes	D-000.80.101



*To upgrade to a rechargeable instrument with mini NT table charger, please see page 146.

HEINE mini3000 pocket instruments – a complete range of quality diagnostic instruments for your pocket. Available in black or blue. Please specify the colour you prefer when ordering. If not otherwise specified, we will supply black instruments.

HEINE mini3000® LED Fiber Optic (F.O.) Diagnostic Sets

LED HQ
LED NOW IN HEINE QUALITY.



Set complete with: **mini3000 LED Fiber Optic (F.O.) Otoscope**
1 set (4 pcs.) reusable tips (B-000.11.111)
5 each of 2.5 and 4 mm dia. AllSpec disposable tips (B-000.11.119)
hard case

mini3000 LED Fiber Optic (F.O.) Diagnostic Sets	2.5V
mini3000 battery handle with batteries	D-885.20.021



Set complete with: **mini3000 LED Ophthalmoscope, mini3000 LED F.O. Otoscope,**
1 set (4 pcs.) reusable tips (B-000.11.111)
5 each of 2.5 and 4 mm dia. AllSpec disposable tips (B-000.11.119)
hard case

mini3000 LED Fiber Optic (F.O.) Diagnostic Sets	2.5V
2 mini3000 battery handles with batteries	D-886.11.021



Set complete with: **mini3000 LED Ophthalmoscope, mini3000 LED F.O. Otoscope,**
mini NT table charger
5 each of 2.5 and 4 mm dia. AllSpec disposable tips (B-000.11.119)

mini3000 LED Fiber Optic (F.O.) Diagnostic Sets	2.5V
with 2 mini3000 rechargeable handles	D-860.11.022*

*with this Art. No. only available in black.

HEINE AllSpec® Disposable tips



- ⊗ **For single use.** Hygienic, no cross-infection.
- ⊗ **Original HEINE design.** Firm fit to the otoscope head.
- ⊗ **Assured quality.** No sharp edges.



AllSpec Disposable tips (grey) for BETA200, K180, mini3000 F.O., mini3000 Otoscopes	
Pack of 1000 pcs. 2.5mm dia. (infants) [03]	B-000.11.128
Pack of 1000 pcs. 4mm dia. (adults) [03]	B-000.11.127
Case of 10 dispenser packs of 250 tips, 2.5 mm dia (infants) [01]	B-000.11.151
Case of 10 dispenser packs of 250 tips, 4 mm dia (adults) [01]	B-000.11.150
AllSpec Tip-dispenser [02]	B-000.11.148

AllSpec Tip-dispenser incl. tips Ø 2.5mm and 4mm [02].
The right size, visible and instantly available. A clean new tip for each and every patient.

⊗: Single use only.



Reusable tips



Ø 2,4 mm Ø 3 mm Ø 4 mm Ø 5 mm

- ∴ **Made of high-density SANALON S plastic with smooth external finish.** Easy to clean. All common germicides can be used. Autoclavable at up to 134 °C.
- ∴ **Ergonomic shape.** Painless atraumatic insertion.
- ∴ **Positive locking design.** Firm fit to the otoscope head.

Reusable tips (black)	1 piece	50 pieces
for BETA200, K180, mini3000 F.O., mini3000 Otoscopes		
Reusable tip 2.4 mm dia.	B-000.11.107	B-000.11.207
Reusable tip 3.0 mm dia.	B-000.11.108	B-000.11.208
Reusable tip 4.0 mm dia.	B-000.11.109	B-000.11.209
Reusable tip 5.0 mm dia.	B-000.11.110	B-000.11.210

1 set = 4 pcs. reusable tips SANALONS 2.4/3/4/5mm dia. **B-000.11.111**

Soft Disposable tips for reusable tips



Ø 3 mm Ø 5 mm

- ∴ **Fits over the end of the AllSpec tip to protect the auditory canal.**

Soft disposable tips (black)		
Soft disposable tip 3 mm dia. 40 pcs./1 pack	B-000.11.141	
Soft disposable tip 5 mm dia. 40 pcs./1 pack	B-000.11.142	

⊗: Single use only.

Insufflation Bulb



- ∴ **For pneumatic testing.**

Insufflation bulb for BETA200 and K180 Otoscopes	B-000.11.240
Insufflation bulb for mini3000 F.O. Otoscope with connector	D-000.80.102
Insufflation port connector for mini3000 F.O. Otoscope	D-000.80.101

Bright XHL Xenon Halogen direct illumination.

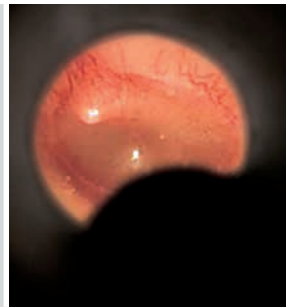
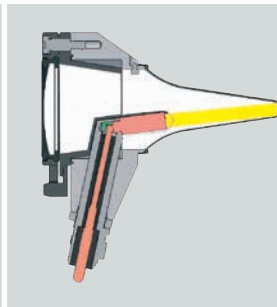

HEINE BETA® 100 Diagnostic Otoscope

Diagnostic Otoscope with an all-metal housing



An otoscope with direct Xenon Halogen illumination in an elegant all-metal instrument head. Unusually-versatile in combination with nasal and spreadable specula for easy instrumentation.

For use with reusable specula or UniSpec disposable specula. With tip-adaptor (B-000.11.306) it is also possible to use AllSpec disposable tips.

- ∴ **All-metal housing.** Exceptionally tough and durable.
- ∴ **Instrument head matt-black inside.** Eliminates reflexes.
- ∴ **XHL Xenon Halogen Technology.** Extremely bright, white light.
- ∴ **Large, scratch-resistant glass viewing window with 3x magnification.** Unobstructed view, distortion-free image.
- ∴ **Swivelling viewing window built into instrument.** Useful for instrumentation, cannot be mislaid.
- ∴ **Insufflation port.** Reliable test of tympanic mobility.
- ∴ **Extensive choice of accessories.** Very versatile e.g. for nasal examination.

- ∴ All-metal housing
- ∴ Silica glass viewing window
- ∴ Easy instrumentation



[01]

BETA100 Diagnostic Otoscope	2.5V	3.5V
with 6 reusable specula, without handle	B-001.11.527	B-002.11.527
without specula, without handle	B-001.11.525	B-002.11.525

XHL Xenon Halogen spare bulb	X-001.88.037	X-002.88.049
------------------------------	---------------------	---------------------

Replacement sleeve for bulb. Reduces reflexes. [01]	B-000.11.212
---	---------------------



HEINE BETA® 100 ENT Diagnostic Sets



Set complete with: **BETA100 Diagnostic Otoscope**
 1 set (6 pcs.) of reusable specula (B-000.11.221)
 10 UniSpec disposable specula, 4 mm dia. (B-000.11.237)
 spare bulb
 hard case

BETA100 Otoscope Sets	2.5V	3.5V (NiMH)	3.5V
BETA battery handle	B-236.10.118		
BETA R rechargeable handle for mains socket		B-236.20.376	B-236.27.376
BETA TR rechargeable handle with plug-in transformer		B-236.20.384	B-236.27.384
BETA NT rechargeable handle and NT300 charger		B-236.20.420	
BETA L rechargeable handle and NT300 charger			B-236.29.420

: Rechargeable handle with charge status display in the bottom insert.

HEINE BETA® Diagnostic Set



Set complete with: **BETA200 Ophthalmoscope, BETA100 Diagnostic Otoscope,**
 1 set (6 pcs.) of reusable specula (B-000.11.221)
 10 UniSpec disposable specula, 4 mm dia. (B-000.11.237)
 one spare bulb each
 hard case

BETA Diagnostic Sets	2.5V	3.5V (NiMH)	3.5V
BETA battery handle	A-234.10.118		
BETA R rechargeable handle for mains socket		A-234.20.376	A-234.27.376
BETA TR rechargeable handle with plug-in transformer		A-234.20.384	A-234.27.384
BETA NT rechargeable handle and NT300 charger		A-234.20.420	
BETA L rechargeable handle and NT300 charger			A-234.29.420

: Rechargeable handle with charge status display in the bottom insert.

HEINE® K100 Diagnostic Otoscope

Diagnostic Otoscope with a high-impact polycarbonate housing



- ∴ Polycarbonate construction
- ∴ Easy instrumentation



[01]

A very cost-effective diagnostic otoscope with direct Xenon Halogen illumination. The head is moulded in high-impact polycarbonate.

For use with reusable specula or UniSpec disposable specula. With tip-adaptor (B-000.11.306) it is also possible to use AllSpec disposable tips.

- ∴ **Polycarbonate construction.** Shock-resistant.
- ∴ **Instrument head matt-black inside.** Eliminates reflexes.
- ∴ **XHL Xenon Halogen Technology.** Extremely bright, white light.
- ∴ **Large acrylic viewing window with 3x magnification.** Sharply-focused distortion-free image.
- ∴ **Swivelling viewing window built into instrument.** Useful for instrumentation, cannot be mislaid.
- ∴ **Insufflation port.** Reliable test of tympanic mobility.

K100 Diagnostic Otoscope	2.5V	3.5V
with 3 reusable specula 3.5/4.5/5.5 mm dia., without handle	B-001.11.576	B-002.11.576
without specula, without handle	B-001.11.575	B-002.11.575

XHL Xenon Halogen spare bulb	X-001.88.037	X-002.88.049
------------------------------	---------------------	---------------------

Replacement cover for bulb [01] Reduces reflexes.	B-000.11.212
---	---------------------

HEINE® K100 ENT Diagnostic Sets

Set complete with: **K100 Diagnostic Otoscope**
1 set (6 pcs.) of reusable specula (B-000.11.221)
spare bulb
soft pouch





K100 Otoscope Sets	2.5V	3.5V (NiMH)	3.5V
BETA battery handle	B-237.10.118		
BETA R rechargeable handle for mains socket		B-237.20.376	B-237.27.376
BETA TR rechargeable handle with plug-in transformer		B-237.20.384	B-237.27.384
BETA NT rechargeable handle and NT300 charger		B-237.20.420	
BETA L rechargeable handle and NT300 charger			B-237.29.420

: Rechargeable handle with charge status display in the bottom insert.

HEINE® K100 ENT Diagnostic Sets



Set complete with: **K100 Diagnostic Oscope**
3 reusable specula (B-000.11.222)
soft pouch



K100 Oscope Sets	2.5V	3.5V (NiMH)	3.5V 
BETA battery handle	B-245.10.118		
BETA R rechargeable handle for mains socket		B-245.20.376	B-245.27.376
BETA TR rechargeable handle with plug-in transformer		B-245.20.384	B-245.27.384
BETA NT rechargeable handle and NT300 charger		B-245.20.420	
 BETA L rechargeable handle and NT300 charger			B-245.29.420

: Rechargeable handle with charge status display in the bottom insert.

HEINE ENT Diagnostic Sets



Set complete with: **K100 Diagnostic Oscope**
3 reusable specula (B-000.11.222)
tongue-depressor for wooden tongue-blades
one spare bulb for each instrument
hard case

ENT Diagnostic Sets	2.5V	3.5V (NiMH)	3.5V 
BETA battery handle	B-241.10.118		
BETA R rechargeable handle for mains socket		B-241.20.376	B-241.27.376
BETA TR rechargeable handle with plug-in transformer		B-241.20.384	B-241.27.384
BETA NT rechargeable handle and NT300 charger		B-241.20.420	
 BETA L rechargeable handle and NT300 charger			B-241.29.420

: Rechargeable handle with charge status display in the bottom insert.

HEINE Operating Otoscope

The greatest flexibility and most options for instrumentation



An all-round otoscope for instrumentation under magnification. Both the lens and speculum can be swivelled.

Ideal for use with nasal and spreadable specula.

For use with reusable specula and UniSpec disposable specula. With tip-adaptor (B-000.11.306) it is also possible to use AllSpec disposable tips.

- ∴ **Open construction.** Ideal for instrumentation.
- ∴ **XHL Xenon Halogen Technology.** Extremely bright, white light.
- ∴ **Swivelling lens and speculum.** Clears the way for access and examination under magnification and illumination.
- ∴ **2.5x lens in protective frame.** Prevents scratching.
- ∴ **The relative positions of light bulb and speculum can be fixed.** Helps with instrumentation, easily returned to normal position.

HEINE Operating Otoscope	2.5V	3.5V
with 1 set = 6 reusable specula, without handle	B-001.11.494	B-002.11.494
without specula, without handle	B-001.11.492	B-002.11.492

XHL Xenon Halogen spare bulb	X-001.88.037	X-002.88.049
------------------------------	---------------------	---------------------

HEINE Operating Otoscope ENT Diagnostic Sets



Set complete with: **Operating Otoscope**

1 set (6 pcs.) of reusable specula (B-000.11.221)

10 UniSpec disposable specula, 4 mm dia. (B-000.11.237)

spare bulb

hard case

Operating Otoscope Sets	2.5V	3.5V (NiMH)	3.5V
BETA battery handle	B-188.10.118		
BETA R rechargeable handle for mains socket		B-188.20.376	B-188.27.376
BETA TR rechargeable handle with plug-in transformer		B-188.20.384	B-188.27.384
BETA NT rechargeable handle and NT 300 charger		B-188.20.420	
BETA L rechargeable handle and NT 300 charger			B-188.29.420

: Rechargeable handle with charge status display in the bottom insert.



HEINE mini3000® Otoscope

Compact pocket otoscope with direct illumination



- ∴ Modern pocket otoscope
- ∴ Switches off automatically
- ∴ Optional rechargeable handle

Modern pocket otoscope in a unique, compact design. Can only be used with the mini3000 handle system. Available in black or blue.

- ∴ **Instrument head matt-black inside.** Eliminates reflexes.
- ∴ **Enhanced XHL Xenon Halogen Technology with 100% more light compared with conventional bulbs.** Very bright, concentrated white light for perfect illumination.
- ∴ **2-piece handle and head.** Easy to maintain, flexible. Compatible with other mini3000 instrument heads.
- ∴ **Viewing window with 3x magnification** and optimized casing surface for razor-sharp images and minimal reflection.
- ∴ **Swivelling viewing window built into instrument.** Useful for instrumentation, cannot be mislaid.
- ∴ **High-quality handle: Chrome-finish upper section/ refined plastic.** Shockproof, sturdy, non-slip.
- ∴ **Attachment clip with integrated on/off switch.** Secure. Switches off automatically when returned to the pocket. 20.000 switch cycles guaranteed.
- ∴ **Replaceable batteries.** Size AA, or optional rechargeable battery with mini NT table charger*.

mini3000 Otoscope	2.5V
with mini3000 battery handle and 1 set (4 pcs.) reusable tips and 5 of both AllSpec disposable tips 2.5 and 4 mm dia., with batteries	D-001.70.220
with mini3000 battery handle and 5 of both AllSpec disposable tips 2.5 and 4 mm dia., with batteries	D-001.70.210
with bulb, without handle and without accessories	D-001.70.206



XHL Xenon Halogen spare bulb	X-001.88.110
------------------------------	--------------

*To upgrade to a rechargeable instrument with mini NT table charger, please see page 146.

HEINE mini3000® Diagnostic Sets



Set complete with: **mini3000 Otoscope**
1 set (4 pcs.) reusable tips
5 each of 2.5 and 4 mm dia. AllSpec disposable tips
hard case

mini3000 Diagnostic Sets	2.5V
mini3000 battery handle with batteries	D-851.20.021



Set complete with: **mini3000 Ophthalmoscope, mini3000 Otoscope,**
1 set (4 pcs.) reusable tips
5 each of 2.5 and 4 mm dia. AllSpec disposable tips
hard case

mini3000 Diagnostic Sets	2.5V
2 mini3000 battery handles with batteries	D-873.21.021

HEINE UniSpec® Disposable Ear Specula



2,5 mm dia.



4 mm dia.



- ∴ **Disposable.** Hygienic and safe.
- ∴ **Original HEINE design and manufacture.** Fit positively to the otoscope.
- ∴ **Assured quality.** No sharp edges.
- ∴ **A clean, new speculum for each and every patient.** The right size visible and instantly available.

UniSpec Disposable Ear Specula (grey)

for BETA100, K100, Operating Otoscope

Pack of 1000, 2,5 mm dia. (infants) 1000 pcs./1 pack	B-000.11.242
Pack of 1000, 4 mm dia. (adults) 1000 pcs./1 pack	B-000.11.241
UniSpec tip dispenser	B-000.11.146

⊗: Single use only.

Reusable Specula



2.2 mm dia.



2.8 mm dia.



3.5 mm dia.



4.5 mm dia.



5.5 mm dia.



10 mm dia.

- ∴ **Moulded in high-density SANALON S, smooth surface.** Easy to clean, can be disinfected with conventional solutions. Autoclavable at 134 °C.
- ∴ **Ergonomic Design.** Painless and atraumatic insertion.
- ∴ **Metal security lock with bayonet fitting.** Long-lasting, positive fit to the otoscope.

Reusable Specula (black)

for BETA100, K100 and Operating Otoscope

1 set = 5 ear specula and 1 nose speculum	B-000.11.221
3 specula 3.5/4.5/5.5 mm dia.	B-000.11.222
Ear speculum 2.2 mm dia.	B-000.11.215
Ear speculum 2.8 mm dia.	B-000.11.216
Ear speculum 3.5 mm dia.	B-000.11.217
Ear speculum 4.5 mm dia.	B-000.11.218
Ear speculum 5.5 mm dia.	B-000.11.219
Nose speculum 10 mm dia.	B-000.11.220

Universal Speculum



- ∴ **All-metal construction.** Opens symmetrically from 2.5 to 15mm.
- ∴ **Rotate ring to open branches.** Stays put in any position.
- ∴ **For use with Operating Otoscope, BETA100 Diagnostic Otoscope and Fiber Optic Nasal Illuminator.**

Universal Speculum

B-000.11.239

Not recommended for use with K100 Diagnostic Oscopes.

Tip-Adaptor



- ∴ **All-metal construction.** Adaptor for AllSpec disposable tips (p. 15) for use with diagnostic (BETA100, K100) and operating otoscope.

Tip-Adaptor

B-000.11.306

Insufflation Bulb



For Diagnostic Oscopes.

- ∴ **For pneumatic testing.**

Insufflation bulb for BETA 100 and K100 Oscopes

B-000.11.240

Tongue-Blade Holder

For wooden tongue-blades



- ∴ **XHL Xenon Halogen Technology.** Concentrated illumination of oral cavity and pharynx.
- ∴ **Light-guide for bulb.** Avoids dazzle.

Tongue-Blade Holder	2.5V	3.5V
for wooden tongue-blades, without handle	B-001.12.302	B-002.12.302
XHL Xenon Halogen spare bulb	X-001.88.037	X-002.88.049
Replacement light-guide for bulb [01]		B-000.12.308

Tongue-Blade Holder

With Blade Ejector for use with HEINE disposable Tongue-Blades



- ∴ **XHL Xenon Halogen Technology.** Concentrated illumination of oral cavity and pharynx.
- ∴ **Light-guide for bulb.** Avoids dazzle.
- ∴ **Blade ejector.** No need to touch used blades.
- ∴ **Only for HEINE disposable plastic tongue-blades.** Strong and hygienic.

Tongue-Blade Holder	2.5V	3.5V
with blade ejector, without handle	B-001.12.305	B-002.12.305
XHL Xenon Halogen spare bulb	X-001.88.037	X-002.88.049
Pack of 100 disposable plastic tongue-blades		B-000.12.304

HEINE mini3000® Tongue-Blade Holder

With blade ejector for HEINE Disposable Tongue-Blades



Can only be used with the mini3000 handle system.

- ∴ **Finger-tip pressure releases the used blade.** No need to touch the blade after use.
- ∴ **XHL Xenon Halogen Technology.** Concentrated illumination of oral cavity and pharynx.
- ∴ **Only for HEINE Disposable Tongue-Blades.** Strong and hygienic.

mini3000 Tongue-Blade Holder	2.5V
Tongue-blade holder head with bulb, without handle [01]	D-001.74.100
complete with mini3000 battery handle* and 5 disposable blades, with batteries [02]	D-001.74.118
XHL Xenon Halogen spare bulb	X-001.88.037
Pack of 100 disposable plastic tongue-blades	B-000.12.304

* Available in black or blue. Please specify the colour you prefer when ordering. If not otherwise specified, we will supply black instruments.

HEINE® mini-c Clip Lamp

Compact, long-life pocket diagnostic light



Sturdy, long-life pocket diagnostic light in a compact, modern design with chrome head. Bright, concentrated light thanks to novel XHL Xenon Halogen lens-bulb.

mini-c Clip Lamp only fits mini-c handles. The mini-c handle is not compatible with mini3000 instruments. Handle available in black or blue.

- ∴ **Clip Lamp with Ear Light for otoplasty.** The Ear Light is used to ensure that hearing aids fit correctly.
- ∴ **Compact, oval, attractive light.** Lies ergonomically in the hand.
- ∴ **High-quality handle: Chrome-finish upper section/refined plastic.** Shockproof, sturdy, non-slip.
- ∴ **Attachment clip with integrated on/off switch.** Secure. Switches off automatically when replaced in the pocket. 20.000 switch cycles guaranteed.
- ∴ **Replaceable batteries.** Size AAA.
- ∴ **Registered Design.**

mini-c Clip Lamp	2.5V
with batteries (in blister pack) [01]	D-001.73.109
with Ear Light with batteries (in blister pack) [02]	D-001.73.103
Ear Light for mini-c Clip Lamp, 6 pieces in blister pack [03]	D-000.73.105
XHL Xenon Halogen spare bulb	X-001.88.108



HEINE mini3000 pocket instruments – a complete range of quality diagnostic instruments for your pocket. Available in black or blue. HEINE mini3000 Clip Lamp and mini-c Clip Lamp attachments are only available with a chrome head. Please specify the colour you prefer when ordering. If not otherwise specified, we will supply black instruments.

HEINE mini3000® Clip Lamp

Compact, long-life pocket diagnostic light

Sturdy, long-life pocket diagnostic lights in a compact, modern design with chrome head. Bright, concentrated light thanks to novel XHL Xenon Halogen lens-bulb.

Can only be used with the mini3000 handle system. Handle available in black or blue.



[01]

[02]

- ∴ Long-life pocket light
- ∴ Switches off automatically
- ∴ Optional rechargeable handle

- ∴ **Compact, oval, attractive light.** Lies ergonomically in the hand.
- ∴ **2-piece handle and head.** Easy to maintain, flexible. Compatible with other mini3000 instrument heads.
- ∴ **Enhanced XHL Xenon Halogen lens-bulb with 100% more light compared with conventional bulbs.** Bright, focused light.
- ∴ **High-quality handle: Chrome-finish upper section/refined plastic.** Shockproof, sturdy, non-slip.
- ∴ **Attachment clip with integrated on/off switch.** Secure. Switches off automatically when replaced in the pocket. 20.000 switch cycles guaranteed.
- ∴ **Replaceable batteries.** Size AA, or optional rechargeable battery with mini NT table charger*.
- ∴ **Ear Light for otoplasty [02].** The Ear Light is used to ensure that hearing aids fit correctly.



mini3000 Clip Lamp	2.5V
complete with mini3000 battery handle, with batteries [01]	D-001.73.131
mini3000 Clip Lamp head without handle	D-001.73.130
Ear Light for mini3000 Clip Lamp, 6 pieces in blister pack [02]	D-000.73.105
XHL Xenon Halogen spare bulb	X-001.88.107

*To upgrade to a rechargeable instrument with mini NT table charger, please see page 146.

HEINE mini3000 pocket instruments – a complete range of quality diagnostic instruments for your pocket. Available in black or blue. HEINE mini3000 Clip Lamp and mini-c Clip Lamp attachments are only available with a chrome head. Please specify the colour you prefer when ordering. If not otherwise specified, we will supply black instruments.



HEINE mini3000® Combi Lamp

Compact, all purpose illuminator with integrated tongue-blade holder

Sturdy, long-life pocket diagnostic light in a compact, modern design. Bright, concentrated light thanks to novel XHL Xenon Halogen lens-bulb.

Can only be used with the mini3000 handle system.
Available in black or blue.

- ∴ **Many applications.** Can be used as a general illuminator and as an illuminated tongue-blade holder for wooden blades and HEINE disposable blades.
- ∴ **2-piece handle and head.** Easy to maintain, flexible. Compatible with other mini3000 instrument heads.
- ∴ **Enhanced XHL Xenon Halogen lens-bulb with 100% more light compared with conventional bulbs.** Bright, focused light.
- ∴ **High-quality handle: Chrome-finish upper section/refined plastic.** Shockproof, sturdy, non-slip.
- ∴ **Attachment clip with integrated on/off switch.** Secure. Switches off automatically when replaced in the pocket. 20.000 switch cycles guaranteed.
- ∴ **Replaceable batteries.** Size AA, or optional rechargeable battery with mini NT table charger*.



[01]

mini3000 Combi Lamp	2.5V
on mini3000 Battery Handle with 5 disposable blades and batteries	D-001.76.120
without handle	D-001.76.101
XHL Xenon Halogen spare bulb	X-001.88.107
Box of 100 disposable tongue-blades [01]	B-000.12.304



*To upgrade to a rechargeable instrument with mini NT table charger, please see page 146.



HEINE mini3000 pocket instruments – a complete range of quality diagnostic instruments for your pocket. Available in black or blue. Please specify the colour you prefer when ordering. If not otherwise specified, we will supply black instruments.